

## First Night Raleigh Art Putt

### CALL TO ARTISTS

**WHAT:** Art Putt will be an interactive art installation featuring a miniature golf course of nine artist-designed mini-golf holes.

**WHEN:** December 28-December 31, 2015

**WHERE:** Inside Historic Market Hall in City Market in Downtown Raleigh.

**APPLICATIONS SENT TO:** [cameronlaws@artsplosure.org](mailto:cameronlaws@artsplosure.org)

\* \* \* \*

Any Artist or Group of Artists is invited to submit a proposal for one of the nine holes. Think of this as a public art exhibit where folks can interact with your artwork while playing a fun game at the same time! Each selected artist will be featured on the First Night Raleigh website and mobile app in addition to their hole being on display at Art Putt.

The Theme of First Night Raleigh this year is *North Carolina FIRSTS*. We are celebrating all of the unique and quirky ways that North Carolina is #1! Each hole must be designed with this theme in mind.

First Night Raleigh has commissioned set designer Greg Osbeck to construct the actual structure of the individual holes and to make the course cohesive. Artists may select from these base layouts, which are listed at the end of this document, when submitting their designs.

\* \* \* \*

**Designs will be judged on the following criteria:**

**PLAYABILITY:** Aim for a par 3. Each hole should have the chance at getting a hole in one. We strongly encourage you to go out and play mini-golf so the design has true playability. The design must be something that will cater to a diverse set of people in terms of age and culture.

**DURABILITY & SAFETY:** It must be able to withstand hundreds of players of all ages playing the hole. The hole must be safe and present no hazards for the players. Artists will be responsible for any maintenance if any part of the structure breaks.

**FEASIBILITY:** Greg will be available for one 30 minute consult with you as you begin your design...so you will need hole dimensions, materials etc. *Any artistic additions to the provided bases must be easily removable at the end of the installation with no damage to the base.*

**CREATIVITY:** Go Big!

**All proposals must include:**

1. Resume of Artist
2. Three sketches with dimensions of your proposed mini-golf hole with a proposed name for your hole.
3. Brief description of your vision for the hole, specifically as it relates to the theme of NC Firsts.
4. Details in regards to the materials you intend to use etc. Electricity may or may not be available.

\* \* \* \*

Each selected artist will receive a materials stipend of \$500 to construct the hole. No other compensation will be provided. The installation of the course will

take place December 26 and 27. Artist will be required to remove their art from the course on by end of day January 2.

Admission to play the Art Putt Course is by proof of First Night Raleigh 2016 button.

\* \* \* \*

**TIMELINE:**

Proposals Due                      November 15

Winning Entries Selected    November 20

Final designs submitted      December 1

Installation of Designs        December 26 and 27

Art Putt Open                      December 28, 29,30,31 from 10-6 Daily

Strike of Course                January 1 and 2

Choose from one of the following designs:

ART PUTT  
HOLE LAY OUTS

\* Note that the inch measurements  
mark differences in height / elevation

#1

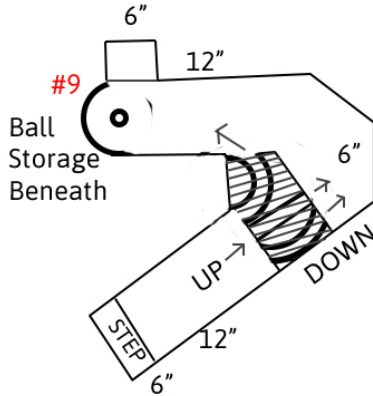
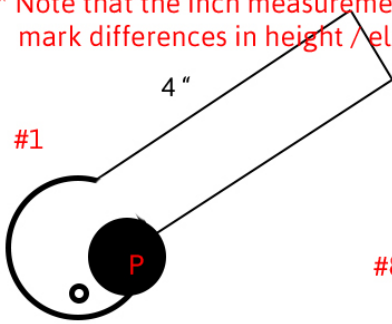

#8

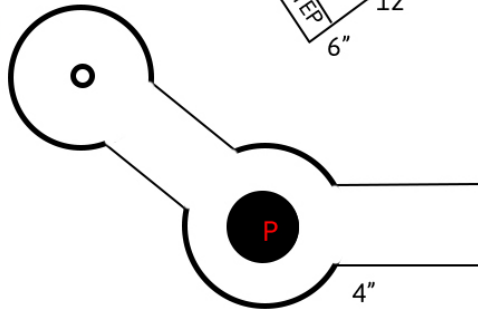

#2

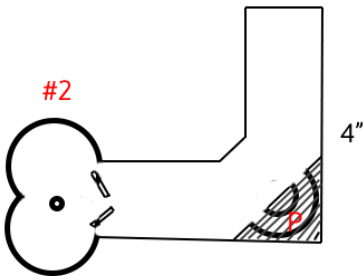

#3

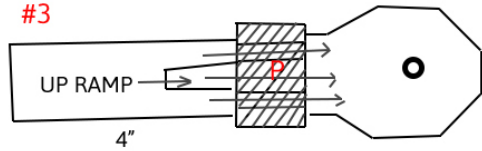

#7

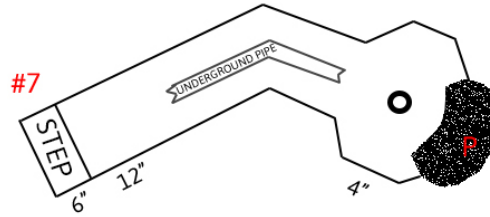

#4

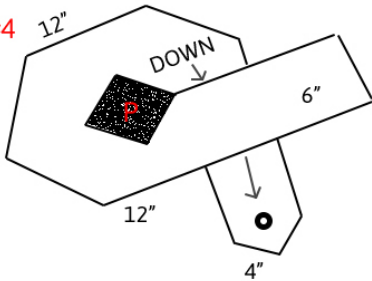

#6

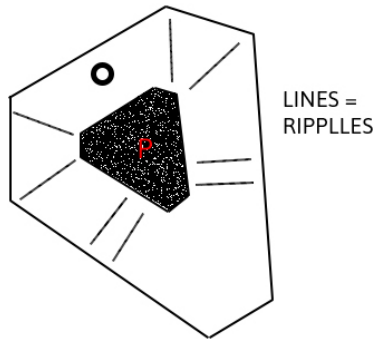

#5

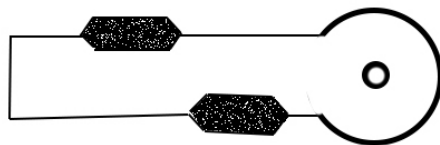

\* P = Level Pedestal (height -2')  
where elements can be added, etc

GREG OSBECK

For Inspiration! Some, but not all, “firsts” from throughout North Carolina. Feel free to incorporate these into your designs or submit your own NC First!

1<sup>st</sup> in Salamander Diversity (in the world)  
1<sup>st</sup> state to declare independence from England  
1<sup>st</sup> Miniature Golf Course  
1<sup>st</sup> Place Babe Ruth hit a home run as professional baseball player  
1<sup>st</sup> in Flight  
1<sup>st</sup> State University (UNC)  
1<sup>st</sup> in Sweet Potato Production (40% of the national supply)  
1<sup>st</sup> English Colony in America  
1<sup>st</sup> Drawbridge  
1<sup>st</sup> X-ray Photograph  
1<sup>st</sup> Krispy Kreme  
1<sup>st</sup> Pepsi Cola  
1<sup>st</sup> Gold Rush  
1<sup>st</sup> Hexagonal House  
1<sup>st</sup> Vicks' Vapor Rub, Goody's Headache Powder  
1<sup>st</sup> Air-Conditioning  
1<sup>st</sup> place Museum for Field Trips in the State NCMNS  
#1 highest peak east of the Mississippi is Mount Mitchell  
1<sup>st</sup> AA to serve in Congress was from NC Hiram Rhodes Revels  
#1 in Sweet Potato Production  
#1 Field Trip Destination is NC Museum of Natural Sciences—it's also  
the most visited Cultural Attraction in the state  
#1 size natural history museum in NC is the NC Museum of History  
#1 tallest mountain in the Eastern US is Mount Mitchell